



McIntosh Laboratory, Inc. 2 Chambers Street Binghamton, New York 13903-2699 Phone: 607-723-3512 www.mcintoshlabs.com

MR89
AM/FM Tuner
Owner's Manual





The lightning flash with arrowhead, within an equilateral triangle, is intended to alert the user to the presence of uninsulated “dangerous voltage” within the product’s enclosure that may be of sufficient magnitude to constitute a risk of electric shock to persons.

WARNING - TO REDUCE RISK OF FIRE OR ELECTRICAL SHOCK, DO NOT EXPOSE THIS EQUIPMENT TO RAIN OR MOISTURE



AVIS RISQUE DE CHOC ELECTRIQUE - NE PAS OUVRIR.
NO USER-SERVICEABLE PARTS INSIDE. REFER SERVICING TO QUALIFIED PERSONNEL

The exclamation point within an equilateral triangle is intended to alert the user to the presence of important operating and maintenance (servicing) instructions in the literature accompanying the appliance.

To prevent the risk of electric shock, do not remove cover or back. No user-serviceable parts inside.

IMPORTANT SAFETY INSTRUCTIONS!

PLEASE READ THEM BEFORE OPERATING THIS EQUIPMENT.

1. Read these instructions.
2. Keep these instructions.
3. Heed all warnings.
4. Follow all instructions.
5. Do not use this apparatus near water.
6. Clean only with a dry cloth.
7. Do not block any ventilation openings. Install in accordance with the manufacturer’s instructions.
8. Do not install near any heat sources such as radiators, heat registers, stoves, or other apparatus (including amplifiers) that produce heat.
9. Do not defeat the safety purpose of the polarized or grounding-type plug. A polarized plug has two blades with one wider than the other. A grounding type plug has two blades and a third grounding prong. The wide blade or the

third prong are provided for your safety. If the provided plug does not fit into your outlet, consult an electrician for replacement of the obsolete outlet.

10. Protect the power cord from being walked on or pinched particularly at plugs, convenience receptacles, and the point where they exit from the apparatus.
11. Only use attachments/accessories specified by the manufacturer.
12. Use only with the cart, stand, tripod, bracket, or table specified by the manufacturer, or sold with the apparatus. When a cart is used, use caution when moving the cart/apparatus combination to avoid injury from tip-over.
13. Unplug this apparatus during lightning storms or when unused for long periods of time.
14. Refer all servicing to qualified service personnel. Servicing is required when the apparatus has been damaged in any way, such as power-supply cord or plug is damaged, liquid has been spilled or objects have fallen into the apparatus, the apparatus has been exposed to



rain or moisture, does not operate normally, or has been dropped.

15. Do not expose this equipment to dripping or splashing and ensure that no objects filled with liquids, such as vases, are placed on the equipment.
16. To completely disconnect this equipment from the a.c. mains, disconnect the AC / DC Adapter from the a.c. receptacle.
17. The mains plug of the power supply cord shall remain readily operable. If the AC / DC Adapter is provided with a mains power supply cord attachment, the plug of this power supply cord shall remain readily operable.
18. Do not expose batteries to excessive heat such as sunshine, fire or the like.
19. Connect mains power supply cord only to a mains socket outlet with a protective earthing connection.

WARNING:

Use this product only with the Power Adapter provided. Failure to do so may result in fire and/or electrical shock.



Outdoor Antenna Grounding

If an outside antenna or cable system is connected to the product, be sure the antenna or cable system is grounded so as to provide some protection against voltage surges and built-up static charge.

Article 810 of the National Electrical Code, ANSI/NFPA 70, provides information with regards to proper grounding of the mast and supporting structure, grounding of the lead-in wire to an antenna discharge unit, and size of ground conductors, location of antenna-discharge unit, connection to ground electrodes and requirements for the grounding electrode.

Example of antenna grounding as per National Electrical Code, ANSI/NFPA 70

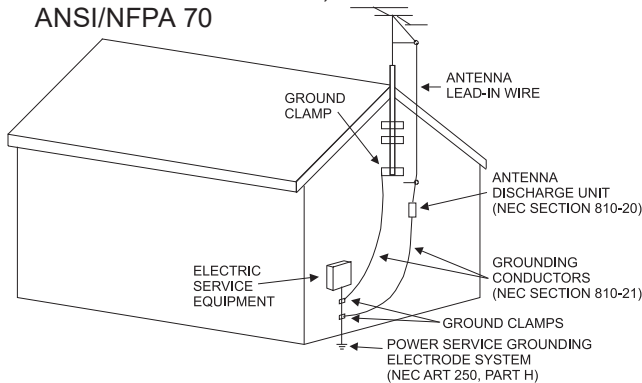

Please Take A Moment

For future reference, you can write down your serial number and purchase information here. We can identify your purchase from this information if the occasion should arise:

Serial Number: _____

Purchase Date: _____

Dealer Name: _____

Table of Contents

Connector and Cable Information	3-4
Introduction	4
Performance Features	4
Dimensions	5
Installation	6
Rear Panel and RAA2 Connections	7
How to Connect Antennas.	8
How to Connect the MR89	9-10
Navigating the Remote Control	11
Front Panel Displays, Controls & Push-buttons	12
How to Operate..	13-21
FM / AM Specifications	22
General Specifications	22
Packing Instructions, Parts List	23

Thank You from all of us at McIntosh

You have invested in a precision instrument that will provide you with many years of enjoyment. Please take a few moments to familiarize yourself with the features and instructions to get the maximum performance from your equipment. If you need further technical assistance, please contact your dealer who may be more familiar with your particular setup including other brands. You can also contact McIntosh with additional questions or in the unlikely event of needing service.

McIntosh Laboratory, Inc.

2 Chambers Street
Binghamton, New York 13903

Technical Assistance: (607) 723-3512

Fax: (607) 724-0549

Customer Service: (607) 723-3515

Fax: (607) 723-1917

Email: support@mcintoshlabs.com

Website: www.mcintoshlabs.com

General Information

- For additional connection information, refer to the owner's manual(s) for any component(s) connected to the MR89 AM/FM Tuner.
- The Main AC Power going to the MR89 and any other McIntosh Component(s) should not be applied until all the system components are connected together. Failure to do so could result in malfunctioning of some or all of the system's normal operations. When the MR89 and other McIntosh Components are in their Standby Power Off Mode, the Microprocessor's Circuitry inside each component is active and communication is occurring between them.
- The Balanced, Unbalanced, and digital Outputs may be used simultaneously.
- The Remote Control Supplied with the MR89 Tuner is capable of operating other components. For additional information go to www.mcintoshlabs.com.
- When discarding the unit, comply with local rules or regulations. Batteries should never be thrown away or incinerated but disposed of in accordance with the local regulations concerning battery disposal.
- For additional information on the MR89 and other McIntosh Products please visit the McIntosh Web Site at www.mcintoshlabs.com.



Connector and Cable Information

XLR Connectors

Below is the Pin configuration for the XLR Balanced Output Connectors on the MR89.

Refer to the diagrams for connections:

PIN 1: Shield/Ground

PIN 2: + Signal

PIN 3: - Signal

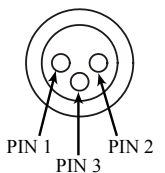



Power Control Connectors

The MR89 Power Control Input/Output Jacks receive/send Power On/Off Signals when connected to other McIntosh Components. A 1/8 inch stereo mini phone plug is used for connection to the Power Control Input/Output on the MR89.

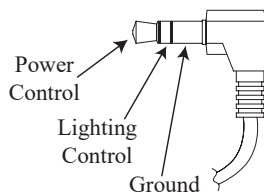

*Note: The Data and Power Control Connecting Cable is available from the McIntosh Parts Department: **Data and Power Control Cable Part No. 170-202.** Six foot, shielded 2 conductor, with 1/8 inch stereo mini phone plugs on each end.*

Data and IR Input Port Connectors

The MR89 Data In Port receives Remote Control Signals. A 1/8 inch stereo mini phone plug is used for connection. The IR Port also use a 1/8 inch stereo mini phone plug and allow the connection of other brand IR Receivers to the MR89.

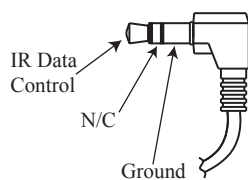
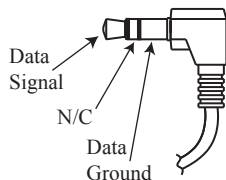

RAA2 Connectors

Pin No.	Wire Color	Pin No.	Wire Color
1.	White/Orange	6.	Green
2.	Orange	7.	White/Brown
3.	White/Green	8.	Brown
4.	Blue		
5.	White/Blue		*Cable outer shield

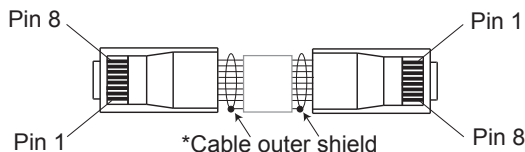

Note: The RAA2 Connecting Cable is available from the McIntosh Parts Department:

RAA2 Antenna Cable Part No. 171844

Twenty foot, shielded 8 conductor, with a shielded RJ45 connector on each end.

Introduction

The MR89 AM/FM Tuner is an elegant instrument for superb reception from Radio Stations. The MR89 uses the latest in technology for the best sound quality, along with a two-line display for convenient operation and comprehensive station information. Meters provide real time insight into the audio program.

Performance Features

• Special FM RF Circuitry

The MR89 RF Circuitry receives strong local FM Station Signals without distortion and receives even the weakest of FM Signals with low noise.

• RAA2 External AM Antenna

The RAA2 External AM Antenna allows placement of the AM Antenna for the best reception.

• Preset Stations and Permanent Memory

The MR89 Tuner stores up to twenty AM and FM Station presets and they are retained in Permanent Memory.

• Balanced Outputs

The Balanced Outputs allow connection of the MR89 to a Preamplifier using long cable lengths without a loss in sound quality.

• Digital Audio Outputs

There are Coaxial and Optical Digital Outputs for external decoding of the PCM Signal.

• Multifunction Fluorescent Display

The Front Panel Display facilitates tuning, setup, and provides signal information while a full complement of RS232 control with metadata support makes the MR89 the go-to multi-format broadcast audio source for today's whole-house systems.

• Information Service

The MR89 will indicate various text information

such as Station Call Sign, Music Genre, Artist Name and Song Title when transmitted by the Radio Station.

• Remote Control with External Sensor Input

The Remote Control provides control of the MR89 operating functions and other McIntosh Source Components. Enjoy your McIntosh System from other rooms in your home by connecting external sensors.

• Power and Lighting Control Input

Power control inputs allow the MR89 to receive power on/off signals from other McIntosh components. While powered, the MR89 meter lighting can be enabled or disabled by other components.

• Power Control Output

A Power Control Output connection for convenient Turn-On of McIntosh Power Components and Accessories is included. The Power Control Output follows the state of the front-panel standby pushbutton, the power control input, and the RS-232 and IR power commands.

• Special Power Supply

Fully regulated Power Supplies and a special R-Core Power Transformer ensure stable noise free operation even though the power line varies.

• Gold Plated Connectors

The MR89 Digital and Analog Audio Connectors are gold plated for superior corrosion resistance and high electrical conductivity.

• Solid State Front Panel Illumination

The even Illumination of the Front Panel and meters is accomplished by extra long life Light Emitting Diodes (LEDs).

• Glass Front Panel and Super Mirror Chassis Finish

The famous McIntosh Illuminated Glass Front Panel and the Stainless Steel Chassis with Super Mirror Finish ensures the pristine beauty of the MR89 will be retained for many years.



Front View of the MR89

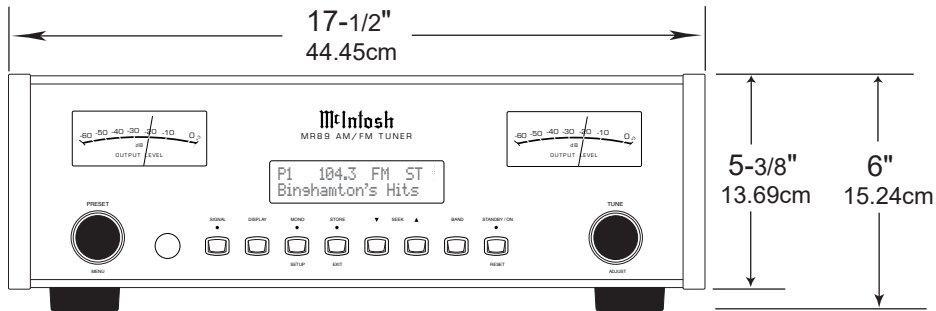

Dimensions

The following dimensions can assist in determining the best location for your MR89.

Side View of the MR89

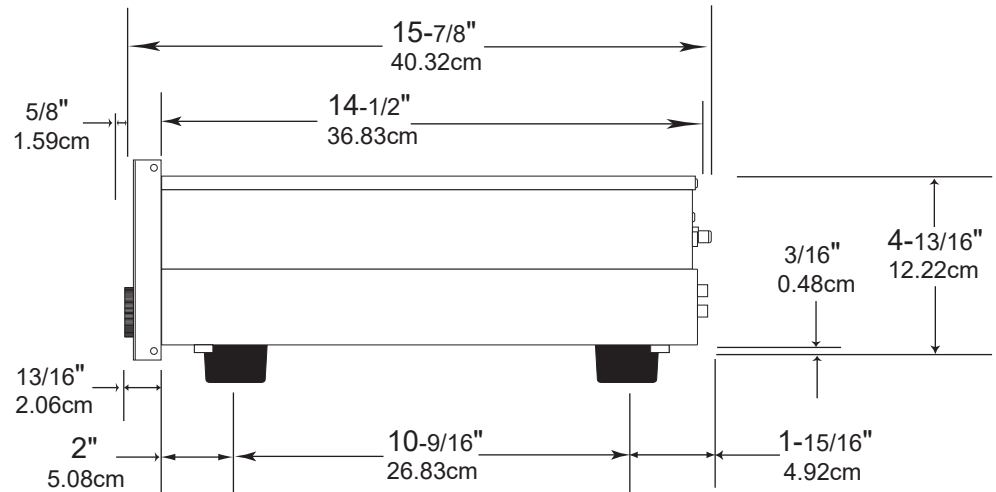

Rear View of the MR89

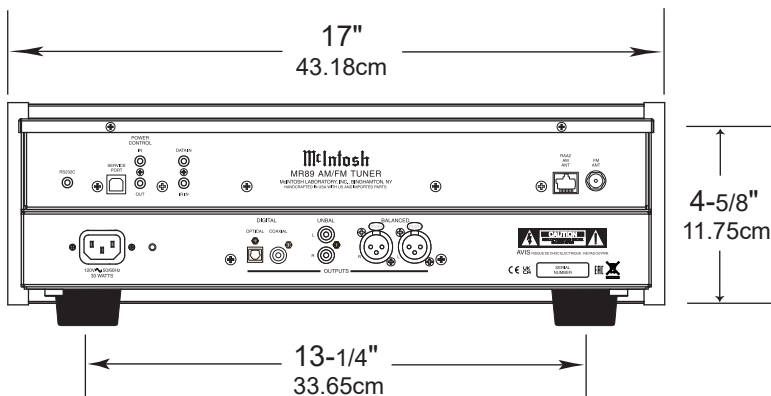



Installation

The MR89 can be placed upright on a table or shelf, standing on its four feet. It also can be custom installed in a piece of furniture or cabinet of your choice.

The four feet may be removed from the bottom of the MR89 when it is custom installed as outlined below. The four feet together with the mounting screws should be retained for possible future use if the MR89 is removed from the custom installation and used free standing. The required panel cutout, ventilation cutout and unit dimensions are shown.

Always provide adequate ventilation for your MR89. Cool operation ensures the longest possible operating life for any electronic instrument. Do not install the MR89 directly above a heat generating component such as a high powered amplifier. If all the components are installed in a single cabinet, a quiet running ventilation fan can be a definite asset in maintaining all the system components at the coolest possible operating temperature.

When the MR89 is placed free-standing on a flat surface, allow at least 2 inches (5.08cm) above the top, 2 inches (5.08cm) below the bottom and 2 inches (5.08cm) on each side of the Tuner, so airflow is not obstructed. Allow 19-1/2 inches (49.53cm) depth behind the front panel. Allow 1-7/16 inch (3.66cm) in front of the mounting panel for knob clearance.

A custom cabinet installation should provide the minimum spacing dimensions for cool operation. Allow at least 2 inches (5.08cm) above the top, 2 inches (5.08cm) below the bottom and 2 inches (5.08cm) on each side of the Tuner, so airflow is not obstructed.

The Custom Cabinet should be open backed and at least 12 inches (30.48cm) away from any surface such as a wall. Be sure to cut out a ventilation hole in the mounting shelf according to the dimensions in the drawing. Allow 1-7/16 inch (3.66cm) in front of the mounting panel for knob clearance.

**MR89 Front Panel
Custom Cabinet Cutout**

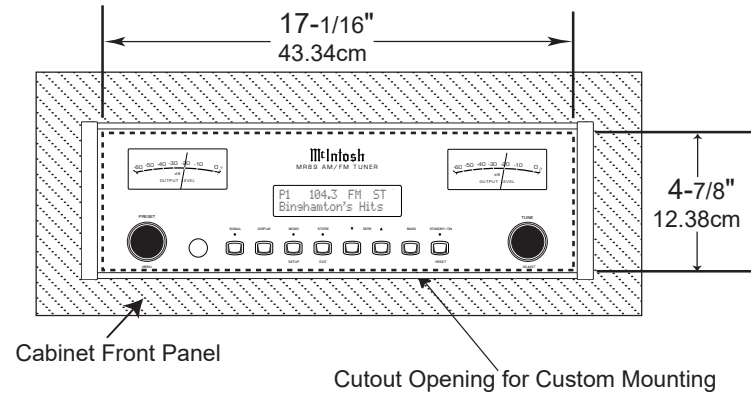

**MR89 Side View
in Custom Cabinet**

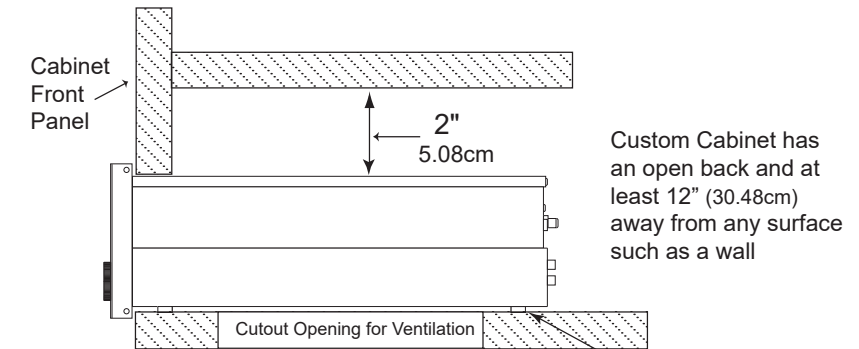

**MR89 Bottom View
in Custom Cabinet**

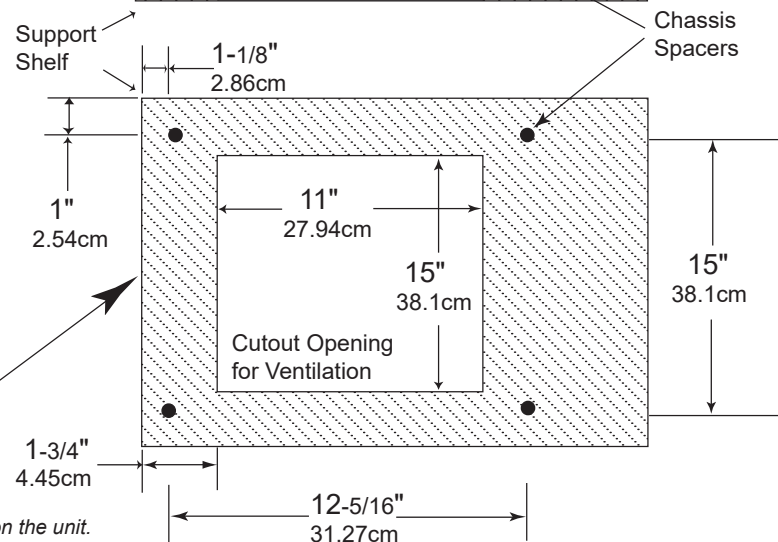

*Note: Center the cutout horizontally on the unit.
For purposes of clarity, the above
illustration is not drawn to scale.*

Rear Panel and RAA2 Connections

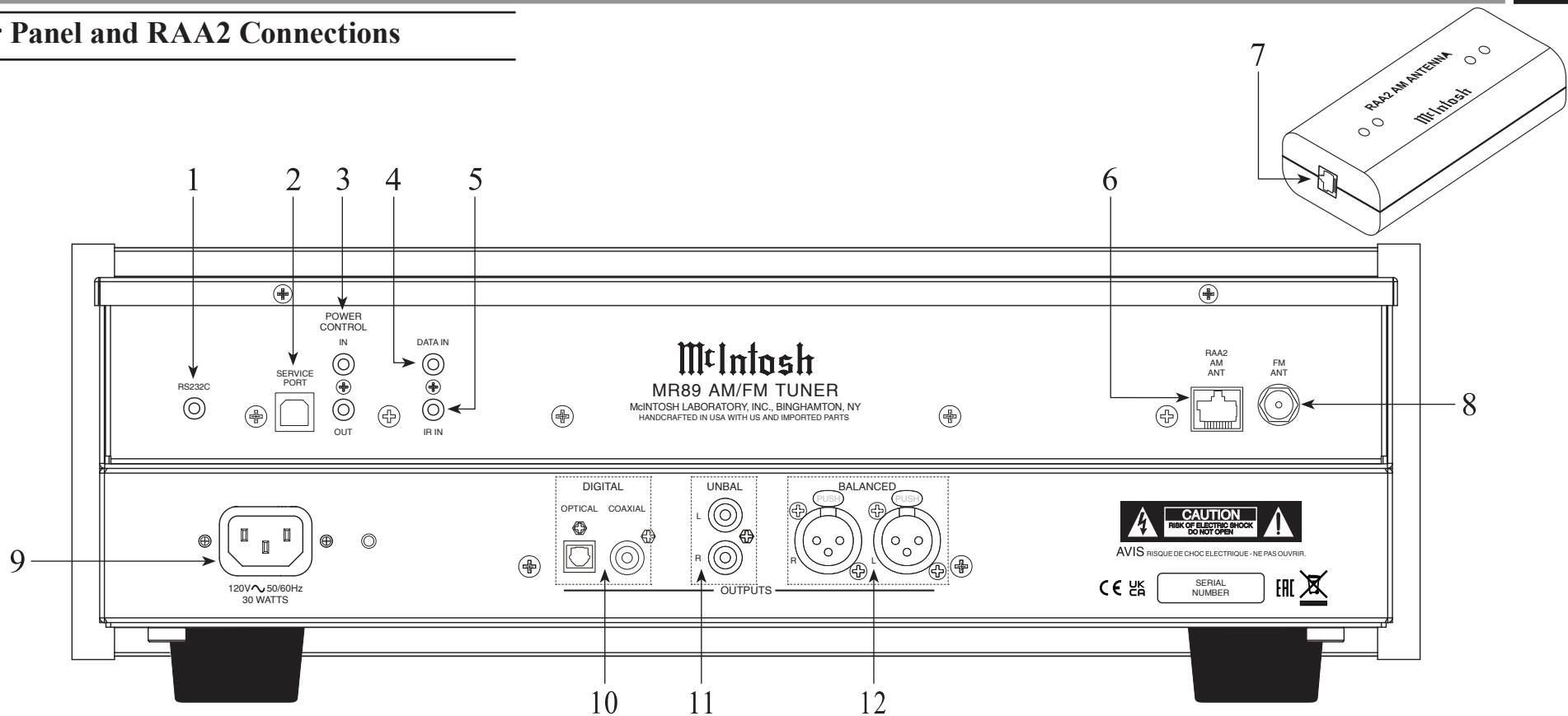

- 1 **RS232** connector for communications with an external control device
- 2 Used for upgrading the MR89 Firmware
- 3 **POWER CONTROL IN** receives power and light control signals from a McIntosh component (5-15 Volts ON, 0 Volts OFF). **POWER CONTROL OUT** sends out a 12V power control signal, and passes the light control signal received at power control in to another McIntosh Component when the MR89 is On.
- 4 **IR Input** for connecting an IR Receiver

- 5 **DATA IN** receives operating data from a McIntosh Preamplifier or Control Center
- 6 **AM ANT** (Antenna) connector allows a McIntosh RAA2 Remote Antenna to be connected
- 7 Connect to the RAA2 AM ANT connector on MR89 using the supplied cable
- 8 **75 OHM FM ANT** (Antenna) connects to an external FM Antenna or cable
- 9 Connect the MR89 power cord to a live AC outlet. Refer to information on the back panel of your MR89 to determine the correct voltage for your unit

- 10 **COAXIAL AND OPTICAL DIGITAL AUDIO OUTPUTS** send signals to a Preamplifier or Control Center with a D/A Converter or a decoder
- 11 **UNBALANCED AUDIO OUTPUTS** supply analog audio signals to Unbalanced Inputs of other components
- 12 **BALANCED AUDIO OUTPUTS** supply analog audio signals to Balanced Inputs of other components



How to Connect Antenna Components

1. Using the supplied shielded cable, connect one end into the RAA2 AM Antenna jack and the other end of the same cable into the MR89 Tuner jack labeled RAA2 AM ANT.

Note: If a longer length cable needs to be used between the MR89 and the RAA2 AM Antenna, use an 8 conductor straight-thru cable with an outer shield and RJ45 connectors on each end (shielded CAT5, CAT5e or CAT6 patch cable).

2. Connect a 75 ohm coax cable from a FM Antenna or cable system to the MR89, 75 OHM FM ANT Connector.

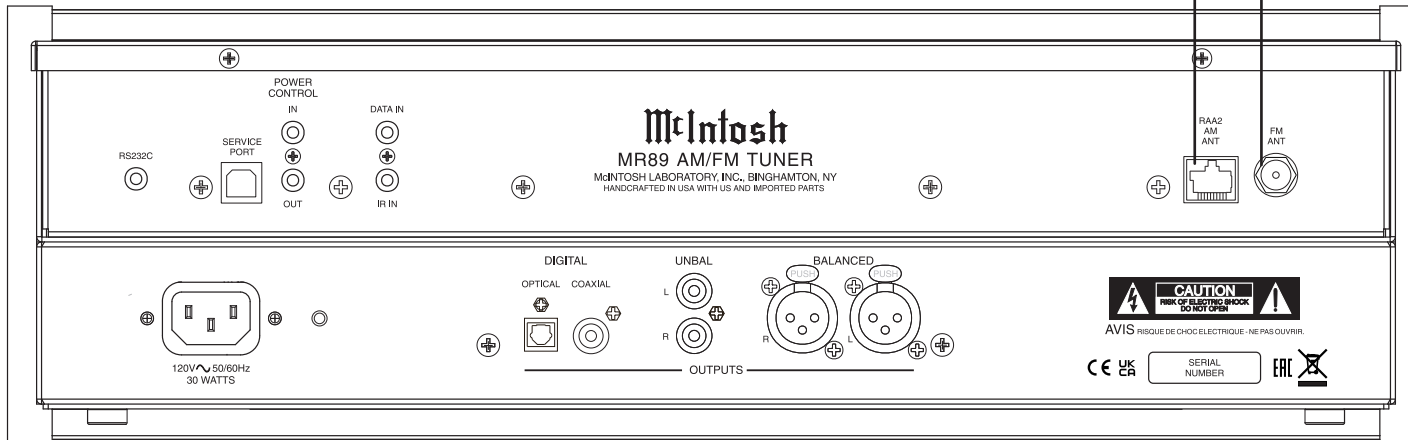
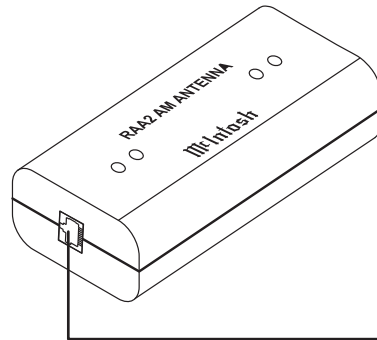
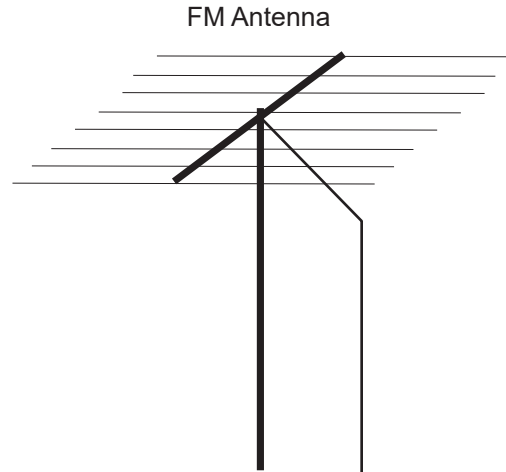

Mounting the RAA2 AM Antenna

Tune to a station with the weakest signal and orient the RAA2 Antenna for maximum signal with minimum noise and distortion. After the location is determined, the RAA2 AM Antenna may be secured to a suitable surface by using two #6 1-3/4 to 2 inches (4.44 to 5.08cm) long screws, refer to the illustration below.

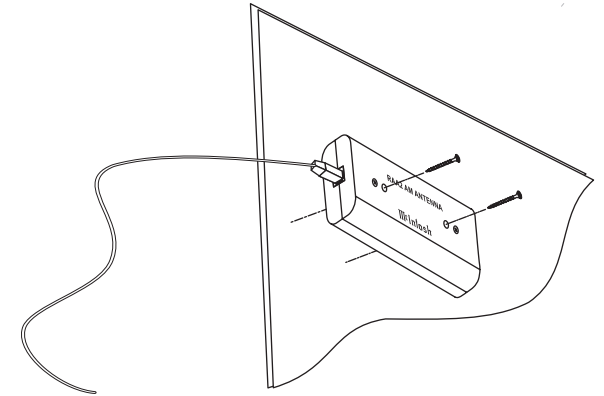



How to Connect the MR89

A/V Control Center

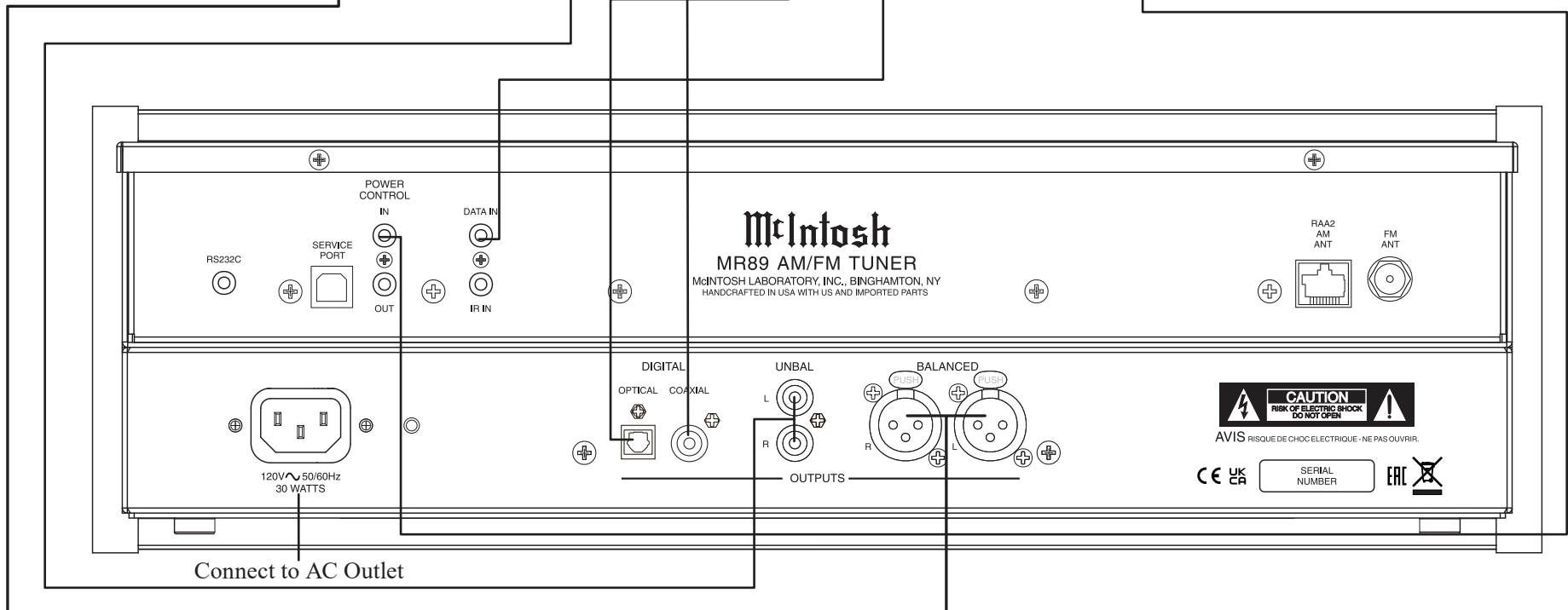
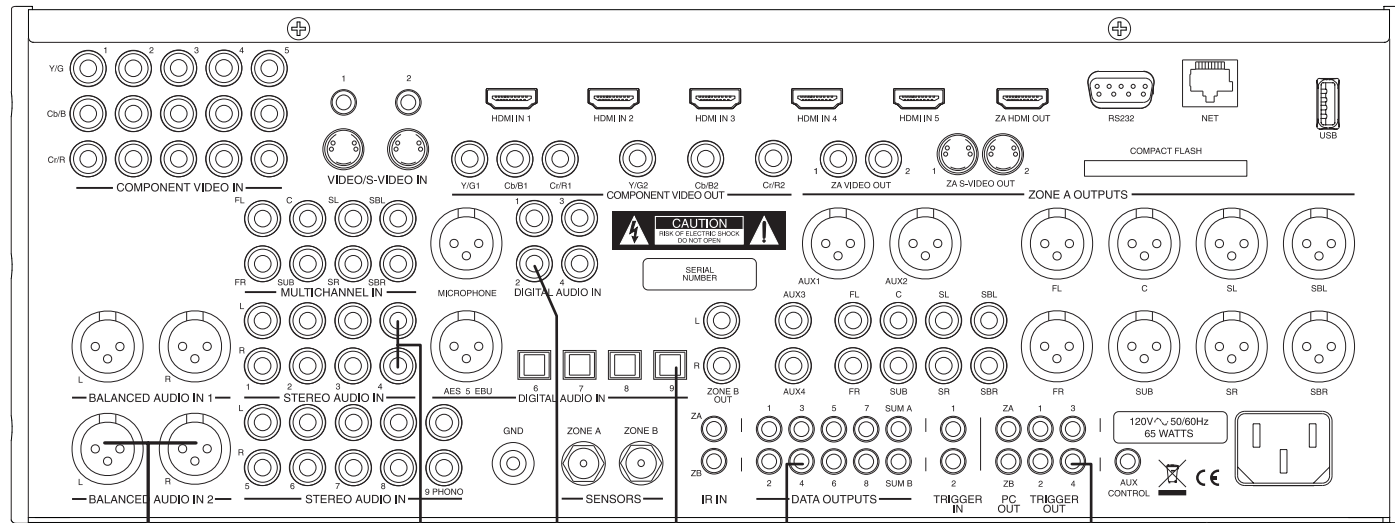

Connect to AC Outlet



How to Connect the MR89

The MR89 has the ability to be remotely switched On/Off from a McIntosh Preamplifier or A/V Control Center via the Power Control connection. When powered, this same connection allows remote control of MR89 meter lighting. The MR89 Data Port Connection allows for the remote operation of basic functions using the Preamplifier or A/V Control Center Remote Control.

With an appropriate IR Sensor connected to the MR89, remote control operation is possible from another room and/or when the MR89 is located in a cabinet with the doors closed.

These connection instructions, together with the MR89 Connection Diagram below, is an example of a typical audio or audio/video system. Your system may vary from this, however the actual components would be connected in a similar manner. For additional information refer to “Connector and Cable Information” on page 3.

Power Control Connections:

1. Connect a Control Cable from the Preamplifier or A/V Control Center appropriate Jack (Tuner/ Trigger 4, Power Control or Trigger) to the POWER CONTROL IN Jack on the McIntosh MR89 Tuner.

2. Connect a Control Cable from the MR89 Tuner POWER CONTROL OUT jack to the next McIntosh Source Component Power Control In Jack.

Data Control Connections:

3. Connect a Control Cable from the Preamplifier or A/V Control Center to the appropriate Data Port Out Jack (Tuner/ 4) to the McIntosh MR89 Tuner DATA IN Jack.

Sensor Connections:

4. Optionally, connect an appropriate IR Sensor to the McIntosh MR89 Tuner IR IN Jack.

Digital Audio Connections:

5. Optionally, connect a Cable from the McIntosh

MR89 Tuner OPTICAL or COAXIAL to the appropriate Optical or Coaxial Input (Tuner/ 9) on the Preamplifier or A/V Control Center.

6. Optionally, connect a Cable from the McIntosh MR89 Tuner remaining DIGITAL Output to the appropriate Optical or Coaxial Input on another Preamplifier or A/V Control Center.

Analog Audio Connections:

7. Connect Balanced Cables from the McIntosh MR89 Tuner BALANCED OUTPUT Connectors to the appropriate (Tuner/Balanced Audio In 2) Preamplifier or A/V Control Center Balanced Input Connectors.

8. Optionally, connect an Audio Cable from the MR89 Tuner UNBALANCED OUTPUT Jacks to the appropriate (Tuner/Stereo Audio In 4) Preamplifier or A/V Control Center Balanced Input Jacks.

Note: Preamplifiers require either a Balanced or Unbalanced audio connection. A/V Control Centers usually require unbalanced connections for proper operation of Zone B and the record output, with Balanced connections as optional.

AC Power Cords Connections:

9. Connect the McIntosh MR89 Tuner AC Power Cord to a live AC outlet.

How to use the Remote Control

The Remote Control is capable of performing basic Operating Functions for the MR89 AM/FM Tuner.

Note: Refer to the “Navigating the Remote Control” Section of this manual for additional information using this Remote Control, on page 11.

Manual Tuning

Use the BAND Push-button to select AM or FM. Press the DIRECTIONAL Up▲ or Down▼ Push-button on the inner ring to move from station to station (AM or FM).

Automatic Tuning

Use the BAND Push-button to select AM or FM. Press the SEEK ◀ down or ▶ up to move to the next station (AM or FM).

Preset Tuning

Use the BAND Push-button to select AM or FM. Press the PRESET ◀◀ down or ▶▶ up Push-button and the MR89 will stop on the next Station in Preset Memory.

Note: For information on entering a Station into memory, refer to page 19.

Direct Preset Access

To access the desired Station previously assigned to a Preset stored in memory, perform the following:

1. Press the BAND Push-button to select AM or FM desired Preset.
2. Press the PRESET Push-button.
3. Using the 0 through 9 numeric Push-buttons enter the Preset Number.

Note: When selecting a Preset 1 through 9 and there are more than ten Presets entered into memory for the given Band (AM or FM) there is a slight delay before the MR89 will go to the single digit Preset.

Direct Station Access

To access a desired Station perform the following:

1. Press the BAND Push-button to select AM or FM desired Preset.
2. Using the 0 through 9 numeric Push-buttons enter the Frequency Number of the Station (for AM or FM).

Note: When in FM, enter 1057 for 105.7 FM, when in AM, enter 1050 for 1050kHz AM.

Navigating the Remote Control

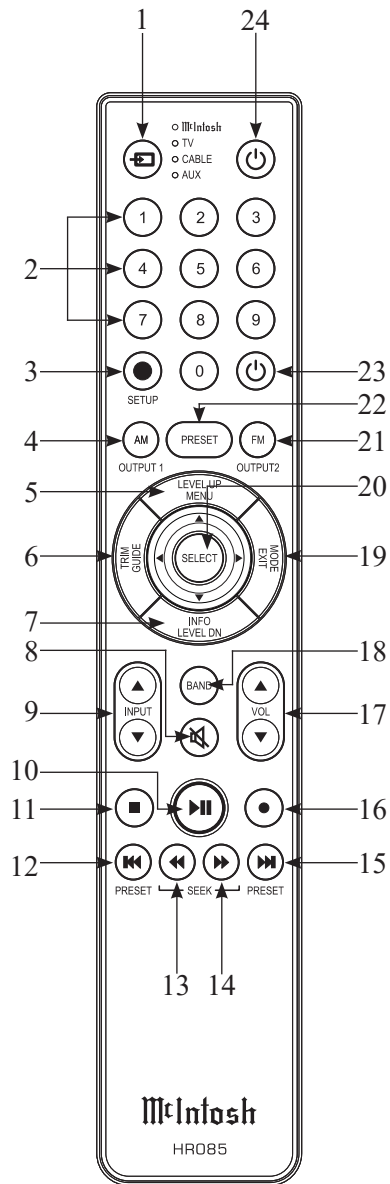

- 1. Switch Device:** Select different devices for remote operation. Selected device is indicated by the LED light when buttons are pressed.
- 2. Numbers:** You can select tuner presets and manually enter and radio stations – among other numerical functions – using these buttons.
- 3. Setup:** The Setup Button gives you access to the additional functions for the buttons represented in blue text. It's like using the “Shift” key on a keyboard to access special characters above the number keys. (*Note: Cannot be used to enter Setup Mode.*)
- 4. AM/Output 1:** Access AM Tuner.
- 5. Level Up/Menu:** Adjusts trim functions settings. Accesses menu on compatible devices.
- 6. Trim/Guide:** Enters Trim Functions Menu. Opens guide on compatible devices.
- 7. Info/Level Down:** Adjusts trim functions settings. Accesses info on compatible devices.
- 8. Mute:** Mutes audio playback.
- 9. Input:** Changes and selects different inputs.
- 10. Play/Pause:** Pressing this button will halt playback of active media, and it will resume from where it left off if you press the button again.
- 11. Stop:** Cancels media playback and resets progress through it.
- 12. Previous/Previous Preset:** You can go back to your previous media selection by pressing this button. Also allows you to navigate to a previous tuner preset.
- 13. Fast Reverse/Seek Down:** Navigate backwards through the current active media using this button. This is also used to adjust the tuner downwards.
- 14. Fast Forward/Seek Up:** Navigate forward through the current active media using this button. This is also used to adjust the tuner upwards.
- 15. Next/Next Preset:** You can go forward to your next media selection by pressing this button. Also allows you to navigate to a later tuner preset.
- 16. Record:** On devices with a record function, this will begin recording the actively playing media.
- 17. Volume:** Adjust the volume with these buttons.
- 18. Band:** You will have the option to change the band on your connected tuner or select certain options on a variety of McIntosh models.
- 19. Mode/Exit:** This will exit the Trim Functions Menu. It will also display information or certain options.
- 20. Select:** Where applicable, you can press this button to select any highlighted option.
- 21. FM/Output 2:** Access FM Tuner.
- 22. Preset:** Press this button followed by a number (0-9) to immediately select that stored preset.
- 23. Power Off:** Whichever device you have selected on the remote control will turn off when you press this button.
- 24. Power On:** Whichever device you have selected on the remote control will turn on when you press this button.

Note: The included McIntosh HR085 Remote Control has buttons used to control multiple devices. Pushbuttons whose function are not identified herein are for use with other McIntosh products. For more information, refer to HR085 Owner's Manual on www.mcintoshlabs.com.



Front Panel Displays, Controls, and Push-buttons

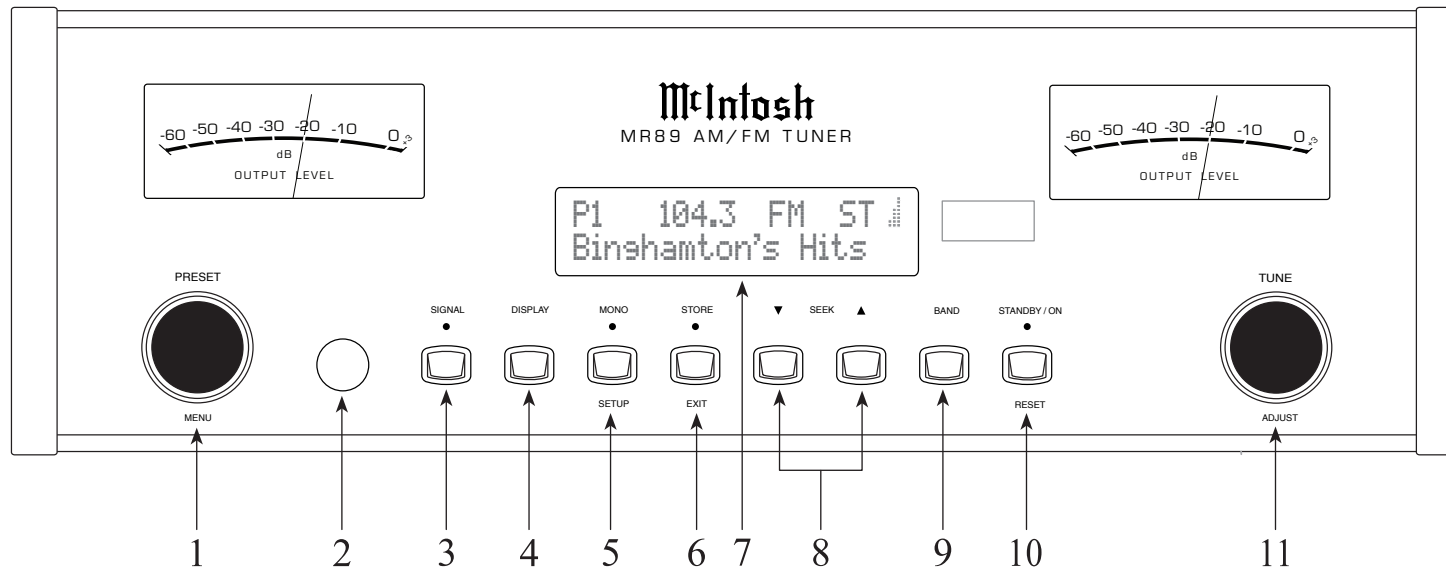

1 PRESET/MENU Control selects Presets for listening or storing the desired radio station. Also used to select various menus when in the setup mode

2 IR Sensor receives commands from a Remote Control

3 SIGNAL Push-button with indicator, activates display of signal quality information applicable to the selected band, such as multipath interference and background noise level

4 DISPLAY selects from various information when transmitted by the Radio Station such as program type, music format artist/song name and is shown on the Information Display

5 MONO/SETUP Push-button with indicator, combines the Left and Right Channel signals for Monophonic Sound on FM Stations; it is also used to enter/exit the Setup Mode

6 STORE/EXIT Push-button with indicator, used to enter and clear stations in Preset Memory; it is also used for various functions in the Setup Mode.

7 INFORMATION DISPLAY indicates FM and AM tuning and signal information; as well as various Operational Functions and Setup Mode Settings

8 SEEK Push-buttons, used to find the next station
10 COAXIAL AND OPTICAL DIGITAL AUDIO OUTPUTS send signals to a Preamp or Control Center with a D/A Converter or a decoder

9 BAND Push-button is used to select the AM or FM tuning band

10 STANDBY/ON Push-button with indicator, switches the MR89 ON or OFF (Standby) and resets the microprocessors

11 TUNE/ADJUST Control selects the desired radio station. Also used to select various items when in the setup mode.



How to Operate the Tuner Setup Mode

Your McIntosh MR89 has been factory configured for default operating settings that will allow immediate enjoyment of superb audio from AM and FM, Radio Stations without the need for further adjustments. Proceed to “How to Operate the MR89 Tuner” at this time unless you wish to make changes to the MR89 factory default settings.

A Setup Feature is provided to customize the operating settings using the Front Panel Information Display. Refer to the MR89 Front Panel Illustration on the opposite page while performing the following steps.

Note: If the MR89 is currently On, proceed to step 2.

1. Press the STANDBY/ON Push-button to switch On the MR89. The MR89 will go through a brief startup initialization with the Front Panel Information Display indicating the last tuned station.

Note: The first time the MR89 is switched On the Tuner will default to the FM Band and is tuned to 88.1 MHz.

2. Press the MONO/SETUP Push-button until the Front Panel Information Display indicates McIntosh MR89 V_._._. firmware version, refer to figure 1.



Figure 1

The firmware governs the operational function of the MR89 Tuner. As enhancements are made, the firmware version is updated. Install the latest firmware for best performance. At this time the LEDs above the STORE/EXIT Push-button will be illuminated.

3. Rotate the MENU (PRESET) Control and notice the Setup Mode goes forward through 20 different possible adjustment selections and three informational displays.
4. To exit from the Setup Mode, press the MONO/SETUP Push-button. The LED above the STORE/EXIT Push-button will extinguish and the Front Panel Display will revert back to its normal display. Refer to figure 2.



Figure 2

Default Settings

The Default Settings Chart below indicates the Function Name, Default Setting and the Page Number for additional information.

MR89 Default Settings		
Function Name	Setting	Pg No.
McIntosh MR89	V_._._, SN: -----	13
AM Seek Sensitivity	Midway	13
FM Seek Sensitivity	Midway	14
Blending Type	Stereo	14
Stereo Blend Mode	Normal	14
Deemphasis	75 μS	14
Soft Mute	Normal	15
Highcut	OFF	15
Clear Presets	None	15
Meter Lights	ON	16
Display Auto Fade	Off	16
Display Brightness	Full Bright	16
Remote IR Sensor	On	16
Remote Power IR	Enable	16
Remote IR Codes	Normal	17
Comm Port Baud Rate	115,200	17
Tuner Type	TM_ _ _ _ _ V_ _ _ _ H0	17
Tuner Region	USA	18
Tuner Radio Text ¹	On	18
Auto-Off:	DISABLED	18
Factory Reset	--	18

Note: In order to change the Tuner Radio Text Setup Setting the Tuner Region needs to be set to “USA”. Refer to Tuner Region on page 18.

AM Seek Sensitivity

AM reception and signal quality varies due to distance from the radio station, radio station power output, sources of interference, placement of the AM Antenna, atmospheric conditions and the time of day (AM vs. PM).

Depending on reception conditions the received AM Station Signals can vary from pleasing to just barely listenable. The MR89 AM Tuner Circuitry incorporates a Variable Sensitivity Control allowing you to determine the listening quality of AM Stations it will stop on while seeking.

To accomplish this perform the following steps:

1. Press the MONO/SETUP Push-button until the Setup Mode is active. Then rotate the PRESET/MENU Control to select Setup Menu item “AM SEEK SENSITIVITY”. Refer to figure 3.



Figure 3

2. Rotate the TUNE/ADJUST Control clockwise to increase the Seek Sensitivity (more stations received, however some might not be listenable, and the MR89 scan may stop on noise or interference). Refer to figure 4.



Figure 4

- Rotate the TUNE/ADJUST Control counterclockwise to decrease the Seek Sensitivity (less stations received, but most will be listenable). Refer to figure 5.



Figure 5



3. Proceed to the next Setup Menu Item or press the MONO/SETUP Push-button to exit the Setup Mode.

FM Seek Sensitivity

Depending on reception conditions, distance from the radio station, radio station power output, placement and type of the FM Antenna, multipath interference and atmospheric conditions the received FM Station Signals can vary from pleasing to just barely listenable. The MR89 FM Tuner Circuitry incorporates a Variable Sensitivity Control allowing you to determine the listening quality of FM Stations it will stop on while seeking.

To accomplish this perform the following steps:

1. Press the MONO/SETUP Push-button until the Setup Mode is active. Then rotate the PRESET/MENU Control to select Setup Menu item “FM SEEK SENSITIVITY”. Refer to figure 6.



Figure 6

2. Rotate the TUNE/ADJUST Control clockwise to increase the Scan Sensitivity (more stations received, however some might not be listenable), refer to figure 7.



Figure 7

- Rotate the TUNE/ADJUST Control counterclockwise to decrease the Scan Sensitivity (less stations received, most will be listenable), refer to figure 8.



Figure 8

3. Proceed to the next Setup Menu Item or press the MONO/SETUP Push-button to exit the Setup Mode.

Stereo Blend Type

When receiving low quality (weak, noisy, multipath) FM Stereo Broadcasts, background noise can be reduced by blending some of the left and right channel information together, while still maintaining “The Stereo Effect.” The MR89 provides two different blending types to select from, conventional Stereo Blending, or Stereo High Blend.

Stereo Blending blends the left and right channel information together uniformly across the audio frequency range as signal quality decreases – blending low and high frequencies the same amount. High Blend blends the high frequency portion of the audio frequency range more aggressively. The highest frequencies are always blended and, as signal quality decreases, more and more of the high frequencies are affected until the effect transitions to conventional Stereo Blending.

To select Blending Type perform the following steps:

1. Press the MONO/SETUP Push-button until the Setup Mode is active. Then rotate the PRESET/MENU Control to select Setup Menu item “SETUP: BLEND TPYE.” Refer to Figure 9.



Figure 9

2. Rotate the TUNE/ADJUST Control to select “STEREO” for conventional Stereo Blending, or “HIGH BLEND” to select High Blend. Refer to Figure 10.



Figure 10

3. Proceed to the next Setup Menu Item or press the MONO/SETUP Push-button to exit the Setup Mode.

Stereo Blend Mode

The MR89 allows changes in the amount of Stereo Separation via the Stereo Blend Function. When receiving weak FM Stereo Broadcasts any background noises can be reduced by blending some of the left and right channel information together, while still maintaining “The Stereo Effect”.

To change from the Normal Setting perform the following steps:

1. Press the MONO/SETUP Push-button until the Setup Mode is active. Then rotate the PRESET/MENU Control to select Setup Menu item “SETUP: STEREO BLEND NORMAL”. Refer to figure 11.



Figure 11

2. Rotate the TUNE/ADJUST Control to select “LESS NOISE” for a reduction in background noise or select “MORE SEPARATION” with a possible increase in background noise over the NORMAL Setting. Refer to figures 12 and 13.

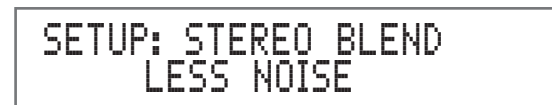

Figure 12



Figure 13

3. Proceed to the next Setup Menu Item or press the MONO/SETUP Push-button to exit the Setup Mode.

Deemphasis

The FM Transmission Standard uses Preemphasis (boosting the volume level of the high frequencies) of the audio signal before transmission. Inside the

tuner Deemphasis (cutting the volume level of the high frequencies) is used to return the audio signal to the correct high frequency volume levels. The use of Preemphasis and Deemphasis helps to reduce losses and noises during the transmission/receive process. There are two different settings for Preemphasis/Deemphasis used today, one is 75µS (microseconds) and other is 50µS. Your Tuner was set to the standard used in your Country. For additional information contact your McIntosh Dealer or FM Broadcasters in your area for the correct setting.

To change Deemphasis Setting, perform the following steps:

1. Press the MONO/SETUP Push-button until the Setup Mode is active. Then rotate the PRESET/MENU Control to select Setup Menu item “SETUP: DEEMPHASIS __ _uS”. Refer to figures 14 and 15.



Figure 14



Figure 15

Softmute

The MR89 provides a Softmute function which can be used to reduce audio output when receiving low quality stations or to reduce between-station static and noise. Several aggressiveness settings are available to suit station quality or listening preference.

To change from the Normal Setting perform the following steps:

1. Press the MONO/SETUP Push-button until the Setup Mode is active. Then rotate the PRESET/MENU Control to select Setup Menu item “SETUP: SOFTMUTE”. Refer to figure 16.

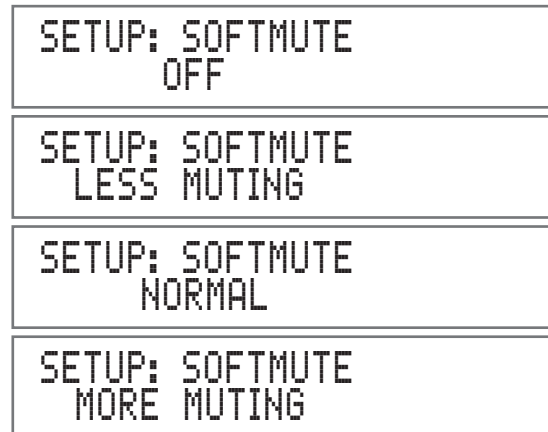

Figure 16

2. Rotate the TUNE/ADJUST Control to “LESS MUTING” to reduce reduction in audio levels when, for example, listening to weak stations. Rotate the Control to “MORE MUTING” for maximum muting of between-station static. The Softmute function can be disabled by rotating the Control to “OFF.”
3. Proceed to the next Setup Menu Item or press the MONO/SETUP Push-button to exit the Setup Mode.

Highcut

The MR89 provides a Highcut function which can be used to reduce high frequency audio content when tuned to low level or low quality stations. Highcut is different from stereo blending in the sense that applies a variable lowpass filter to reduce the high frequency content of poor quality stations, but does not blend the left and right channel content together and reduce stereo separation. Several aggressiveness settings are available to suit station quality or listening preference.

To change from the Normal Setting perform the following steps:

1. Press the MONO/SETUP Push-button until the Setup Mode is active. Then rotate the PRESET/MENU Control to select Setup Menu item “SETUP: HIGHCUT”. Refer to figure 17.

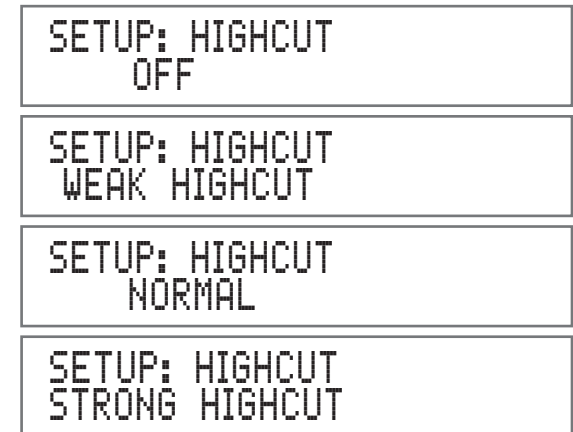

Figure 17

2. Rotate the TUNE/ADJUST Control to “WEAK HIGHCUT” to reduce high frequency attenuation. Rotate the Control to “STRONG HIGHCUT” for more aggressive high frequency attenuation. The Highcut function can be disabled by rotating the Control to “OFF.”
3. Proceed to the next Setup Menu Item or press the MONO/SETUP Push-button to exit the Setup Mode.

Clear Presets

The MR89 AM/FM Tuner has three different Tuning Modes. One of the Tuning Modes is Preset Tuning, where favorite stations are entered into memory for quick recall. Any preset station may be removed from memory at any time. There are times when it may be desirable to remove from memory all or some of the preset stations.

To accomplish this perform the following steps:

1. Press the MONO/SETUP Push-button until the Setup Mode is active. Then rotate the PRESET/MENU Control to select Setup Menu item “SETUP: PRESETS”. Refer to figures 18 thru 21.



Figure 18



```

SETUP PRESETS:
CLEAR PRESETS: AM
  
```

Figure 19

```

SETUP PRESETS:
CLEAR PRESETS: FM
  
```

Figure 20

```

SETUP PRESETS:
CLEAR PRESETS: ALL
  
```

Figure 21

2. Rotate the TUNE/ADJUST Control to select one of four choices:

- NONE** (default setting, No Presets are cleared)
- AM** (all AM Presets are cleared)
- FM** (all FM Presets are cleared)
- All** (all AM and FM Presets are cleared).

Note: The Presets are cleared when the Setup Mode is exited.

3. Proceed to the next Setup Menu Item or press the MONO/SETUP Push-button to exit the Setup Mode.

Meter Lights

Settings are ON, OFF. The rear panel Light Control signal always takes precedence over the Set Up Menu. Refer to figure 22.

```

METER LIGHTS
ON
  
```

```

METER LIGHTS
OFF
  
```

Figure 22

Information Display Brightness

The brightness level of the Front Panel Information Display may be changed from the default setting.

To change the brightness perform the following steps:

1. Press the MONO/SETUP Push-button until the Setup Mode is active. Then rotate the PRESET/MENU Control to select Setup Menu item “DISPLAY BRIGHTNESS”. Refer to figure 23.

```

DISPLAY
BRIGHTNESS
  
```

Figure 23

2. Rotate the TUNE/ADJUST Control to select the desired brightness. The display actively changes brightness as you adjust the control. There are four available settings.
3. Proceed to the next Setup Menu Item or press the MONO/SETUP Push-button to exit the Setup Mode.

Information Display Auto Fade

The Front Panel Information Display Auto Fade Feature may be activated by performing the following steps:

1. Press the MONO/SETUP Push-button until the Setup Mode is active. Then rotate the PRESET/MENU Control to select Setup Menu item “SETUP: DISPLAY AUTO FADE: OFF”. Refer to figure 24.

```

SETUP: DISPLAY
AUTOFADE: OFF
  
```

```

SETUP: DISPLAY
AUTOFADE: ON
  
```

Figure 24

2. Rotate the TUNE/ADJUST Control to select ON. Approximately 15 seconds after there is no change to the operating function (Front Panel or Remote Control), the Front Panel Information Display will blank out until an operating function is accessed.
3. Proceed to the next Setup Menu Item or press the MONO/SETUP Push-button to exit the Setup Mode.

Remote IR Sensor

When an external IR Sensor is connected to the MR89 and located in the same room as the tuner, it is advisable to disable the built-in IR Sensor located on the Front Panel. Disable the sensor by performing the following steps:

1. Press the MONO/SETUP Push-button until the Setup Mode is active. Then rotate the PRESET/MENU Control to select Setup Menu item “SETUP: REMOTE IR SENSOR”. Refer to figure 25.

```

SETUP: REMOTE
IR SENSOR: OFF
  
```

```

SETUP: REMOTE
IR SENSOR: ON
  
```

Figure 25

2. Rotate the TUNE/ADJUST Control to select OFF.
3. Proceed to the next Setup Menu Item or press the MONO/SETUP Push-button to exit the Setup Mode.

Remote Control Power Command

In a typical audio system, the MR89 switches On and Off with the McIntosh Preamplifier or A/V Control Center when a Power Control Connection is made between the units. When the MR89 is used alone, it can be set to be switched On or Off using the Push-button on the MR89 Remote Control.

To activate the Remote Control On/Off feature perform the following steps:

1. Press the MONO/SETUP Push-button until the Setup Mode is active. Then rotate the PRESET/MENU Control to select Setup Menu item "SETUP: REMOTE POWER IR". Refer to figure 26.

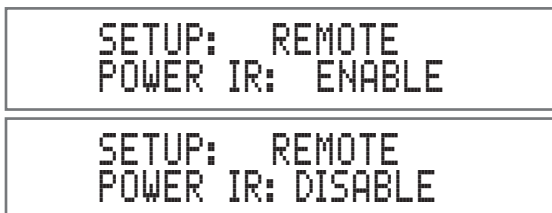

Figure 26

2. Rotate the TUNE/ADJUST Control to select ENABLE.
3. Proceed to the next Setup Menu Item or press the MONO/SETUP Push-button to exit the Setup Mode.

Remote Control Codes

The Remote Control included with the MR89 utilizes the Normal McIntosh Control Codes. The Second Set of Control Codes the MR89 will respond to is referred to as the Alternate Codes.

The Alternate Codes are used when the MR89 is used in the same location as a McIntosh Preamplifier and/or A/V Control Center. This will prevent the Remote Control from affecting the operation of both units at the same time.

To activate the Remote Control Alternate Codes perform the following steps:

1. Press the MONO/SETUP Push-button until the Setup Mode is active. Then rotate the PRESET/MENU Control to select Setup Menu item "SETUP: IR CODES." Refer to figure 27.

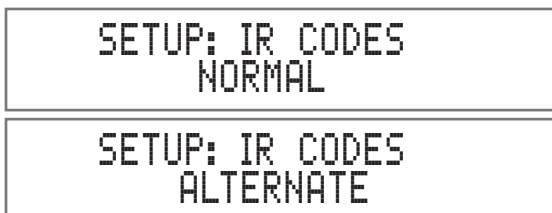

Figure 27

2. Rotate the TUNE/ADJUST Control to select ALTERNATE.
3. To change the MR89's HR085 remote control to the ALTERNATE codes, press and hold the SELECT push-button, followed by the 2 push-button. Hold both push-buttons down for approximately 5 seconds until the McIntosh LED at the top of the remote flashes twice.

Note: To reset the remote control to the NORMAL codes, press and hold the SELECT push-button, followed by the 1 push-button. Hold both push-buttons down for approximately 5 seconds until the McIntosh LED at the top of the remote flashes once.

4. Press the MONO/SETUP Push-button to exit the Setup Mode. Press the BAND Push-button on the Remote Control to verify proper operation.
5. Proceed to the next Setup Menu Item

Comm Port Baud Rate

The MR89 may be remotely controlled from other equipment connected to the Rear Panel RS232C connector. The speed at which the MR89 communicates with other equipment is adjustable from 9,600 bits per second to 115,200 bits per second.

To change from the default speed of 115,200 bits per second, perform the following steps:

1. Press the MONO/SETUP Push-button until the Setup Mode is active. Then rotate the PRESET/MENU Control to select Setup Menu item "SETUP: COMM PORT BAUD RATE". Refer to figure 28.

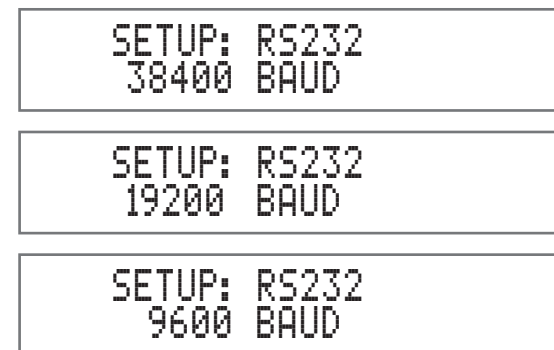
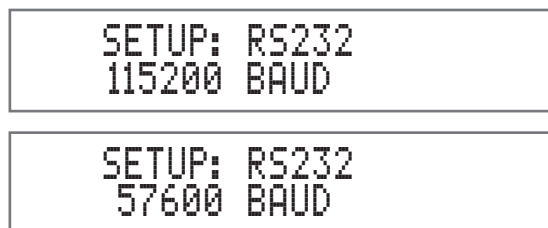

Figure 28

2. Rotate the TUNE/ADJUST Control to select the desired speed.
3. Proceed to the next Setup Menu Item or press the MONO/SETUP Push-button to exit the Setup Mode.

Tuner Type

The MR89 Tuner Type may be checked by performing the following:

1. Press the MONO/SETUP Push-button until the Setup Mode is active. Then rotate the PRESET/MENU Control to select Setup Menu item "SETUP: TUNER TYPE". Refer to figure 29.

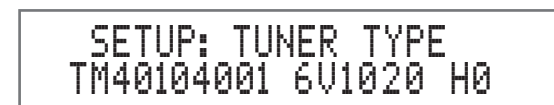

Figure 29

TM4 _____ **V** _____ **H0**
TM4 _____ **V** _____ **H** _____
"0" indicates MR89 detected.

_____ portion is tuner board info.
 _____ portion is tuner device info.
 _____ is tuner - detected host info.

2. Proceed to the next Setup Menu Item or press the MONO/SETUP Push-button to exit the Setup Mode.



Tuner Regions

The MR89 is capable of receiving AM/FM Broadcasts in various parts of the world. In some countries the broadcasters use slightly different standards and the MR89 accommodates these differences.

Your McIntosh MR89 has been factory configured for the broadcast standards in your country.

If for some reason there is need make a change, follow the steps below for changing the receiving standards:

Note: Changing the current Tuner Region will result in clearing of all the Station Presets.

1. Press the MONO/SETUP Push-button until the Setup Mode is active. Then rotate the PRESET/MENU Control to select Setup Menu item "SETUP: TUNER REGION". Refer to figure 30.

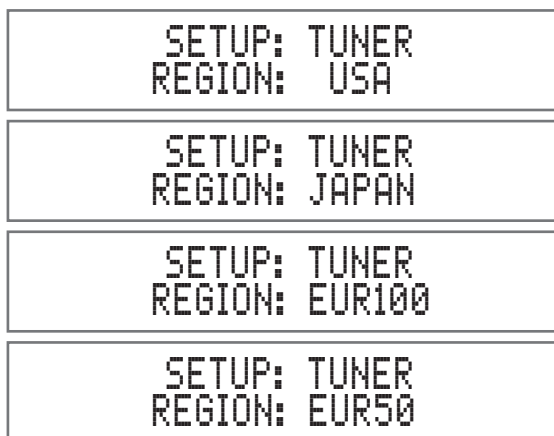

Figure 30

2. Rotate the TUNE/ADJUST Control to select one of four choices.

Setting	AM Band	FM Band
USA	530kHz - 1700kHz	88.1MHz - 107.9MHz
JAPAN	531kHz - 1629kHz	76MHz - 108MHz
EUR 100	531kHz - 1701kHz	87.5MHz - 108MHz
EUR 50	531kHz - 1701kHz	87.5MHz - 108MHz

Note: For additional information contact your McIntosh Dealer.

3. Press the MONO/SETUP Push-button to exit the Setup Mode. The MR89 Tuner will now switch OFF to affect the region change just made. Press the STANDBY/ON Push-button to switch the MR89 back On.
4. Proceed to the next Setup Menu Item.

Tuner Text Information

Some USA FM Stations broadcast program information identifying things such as genre, station, and song title. When Tuner Region in the Setup Menus is set to "USA", the MR89 supports display of this text. Note that the MR89 may not support all of the different language character sets thich an FM station might transmit. When available from a FM Station, the text information appears on the second line of Front Panel Information Display.

The display of the Information can be switched Off by performing the following:

1. Press the MONO/SETUP Push-button until the Setup Mode is active. Then rotate the PRESET/MENU Control to select Setup Menu item "SETUP: TUNER RADIO TEXT". Refer to figure 31.

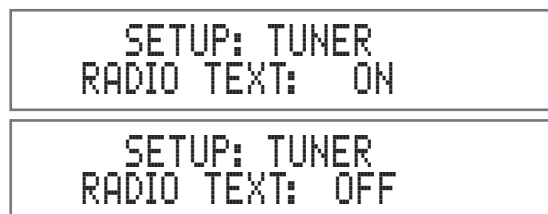

Figure 31

2. Rotate the TUNE/ADJUST Control to switch Off the text.

Note: this setup menu item is only available if Tuner Region is set to "USA."

Auto-Off

The MR89 Auto-off feature is a power-saving mode that automatically places the unit in Standby if no audio

is detected for a period of time. Because of the nature of radio reception and tuner operation, audible static will be present when tuned between stations. This static may be of sufficient audio levels to prevent the auto-off feature from engaging. The auto-off feature will engage and shutdown the MR89 when, for example, it is tuned to a station that has ceased broadcasting a program but the station remains on the air broadcasting "dead air."

By default the Auto-off feature is disabled, but may be enabled by performing the following steps:

1. Press and hold in the MONO/SETUP Pushbutton to enter the SETUP MODE. Then rotate the PRESET/MENU Control to select Setup Menu item "SETUP: AUTO-OFF." Refer to Figure 32.
2. Rotate the TUNE/ADJUST control to select "ENABLED." Refer to Figure 33.
3. Proceed to the next Setup Menu Item or press the MONO/SETUP push-button to exit the setup mode.



Figure 32

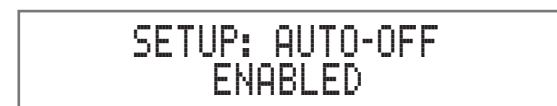

Figure 33

Factory Reset

If it becomes desirable to reset all the adjustable settings (Setup and Presets) to the factory default values, perform the following steps:

1. Press and hold in the MONO/SETUP Pushbutton to enter the SETUP MODE. Then rotate the PRESET/MENU Control until "FACTORY RESET (HOLD MONO)" appears on the Information Display. Refer to Figure 34.
2. Press and hold in the MONO/SETUP Pushbutton until "FACTORY RESET, IN PROGRESS" appears

- on the Information Display, then release the INPUT Control. Refer to Figure 35.
- When complete, the information display will indicate “FACTORY RESET, COMPLETED!” momentarily, refer to figure 36, and then MR89 will automatically shut off.
 - Press the Front Panel STAND/BY Push-button to switch on the MR89



Figure 34



Figure 35



Figure 36

How to Operate

The McIntosh MR89 incorporates an advanced design AM/FM/Tuner with many desirable performance features to enhance your enjoyment of radio broadcasts.

Power On

Press the STANDBY/ON Push-button on the Front Panel or the green (Power) Push-button on the Remote Control. Refer to Remote on page 11, and Front Panel on page 12. The MR89 will go through a brief startup initialization followed by the Front Panel Information Display indicating the last Station.

Note: The first time the MR89 is switched On the Tuner will default to the FM Band.

Band Selection

Press the BAND Push-button on the Front Panel or the AM or FM push-buttons on the Remote Control to select either AM or FM. The display indicates which Band is active, and if FM indicates “ST” when a received radio broadcast is a Stereo Radio Signal.

Several seconds after the AM or FM Band is selected, the Front Panel Information Display will change to indicate the selected band and frequency the tuner is currently tuned to. Refer to Front Panel on page 12.

Tuning Broadcasts

There are three Tuning methods for selection of AM or FM Broadcasts as follows:

- MANUAL Allows Manual Tuning of available AM and FM broadcasts.
- SEEK Automatic Tuning of available AM and FM broadcasts.
- PRESET Selection of AM and FM broadcasts entered into memory.

Manual Tuning

Rotate the TUNE/ADJUST Knob counter-clockwise or clockwise to the desired AM or FM broadcast.

To manually tune with the Remote Control, the inner ring up▲ or down▼ may be used to tune up or down 1 channel at a time, or the numerical keypad may be used to enter tune frequency directly.

The Front Panel Information Display will indicate the band and exact Tune Frequency, and when the MR89 is receiving in Stereo.

On the right side of the Front Panel Information Display, the vertical columns indicate the relative signal strength of the received Station. Refer to figures 37 and 38.

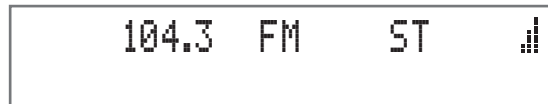

Figure 37

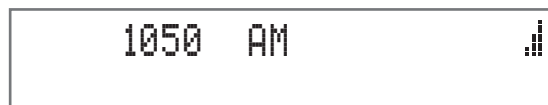

Figure 38

Tuning

The SEEK Tuning Mode (Automatic Tuning) searches the AM or FM Broadcast Bands for available Stations. To use the SEEK Tuning Mode, press and release the SEEK Up▲ or Down▼ Push-buttons on the Front Panel to go up or down the dial; or use the SEEK ◀ down

or SEEK ▶ up the dial Push-buttons on the Remote Control. Refer to Remote on page 11, and Front Panel on Page 12. The MR89 Tuner will automatically stop on the next Station. The seek sensitivity is adjustable in user-setup.

Note: If the signal strength of a Station is weaker than the threshold set in user-setup, SEEK Tuning will not stop on that station.

Preset Tuning

The MR89 allows for presetting 20 AM and 20 FM Stations into memory for rapid recall, without having to manually tune through unwanted Broadcasts. By rotating the PRESET/MENU Control, a Preset may be selected. Until AM or FM presets are stored, the Front Panel Information Display will indicate “NO PRESETS STORED” upon rotation of the PRESET/MENU Control. Refer to figure 39.



Figure 39

Creating Presets

Tune to a Station to be entered into memory either by Manual Tuning or Seek Tuning and then perform the follow steps:

- Momentarily press and release the Front Panel STORE Push-button. The Front Panel Information Display will indicate “PRESET X: AVAILABLE”, where X is the first available Preset Number. Refer to figure 40. The Station to be entered into memory may also be assigned to a different Preset Number (2-20) by rotating the PRESET/MENU Control to select the desired Preset Number.



Figure 40

Notes: 1. Presets are automatically assigned in order from 1 to 20 unless a different Preset Number is selected.



2. To exit without entering a new Preset into memory, momentarily press the Front Panel EXIT (STORE) Push-button.

2. To enter a Station into memory press and hold in the STORE Push-button until the Front Panel Information Display indicates “PRESET STORED” then release the STORE Push-button. Refer to figure 41.



Figure 41

The just entered Preset will be assigned Preset Number 1 (or the Preset number you selected) and is displayed on the Front Panel Information Display. Refer to figure 42.

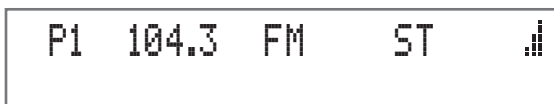

Figure 42

3. Assign additional Stations by performing steps 1 and 2.

Note: When all 20 Presets are assigned and there is another station(s) to be assigned to a Preset, press the STORE Push-button. The second line of the display will indicate the current station stored in Preset Number 1. Either enter the new station into Preset Number 1 or Rotate the PRESET control to select the desired preset to overwrite, and press and hold the STORE push-button to store. Note that the previously stored preset will be lost. Refer to Figure 43.

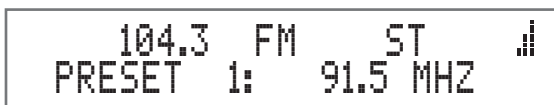

Figure 43

4. To verify the Preset(s) just entered into memory, rotate the Front Panel PRESET/MENU Control or use the PRESET ► or PRESET ◀ Push-buttons on the Remote Control.

Clearing Presets

1. Select the Preset to be removed by using the Front

Panel PRESET/MENU Control or by using the PRESET ► or PRESET ◀ Push-buttons on the Remote Control. Refer to figure 44.

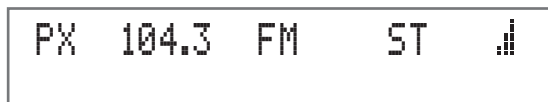

Figure 44

2. Press and hold in the Front Panel STORE Push-button until the Front Panel Information Display indicates “PRESET X CLEARED”, then release the STORE Push-button. Refer to figure 45.



Figure 45

Note: If you wish to replace an already assigned Station Preset with another radio Station, it is not necessary to clear the Preset first, just enter in the new Station for that Preset. The new Station will automatically replace the previously assigned Station.

3. To clear any additional Station Presets perform steps 1 and 2 again.

After the creation of Preset(s), use the Front Panel PRESET/MENU Control to select the desired Station Preset or by using the Remote Control, PRESET ► or PRESET ◀ Push-buttons.

Direct access is also possible by pressing the PRESET Push-button followed by entering the number of Preset using the 0-9 numeric Push-buttons on the Remote Control.

MONO Push-Button Stereo/Mono Mode

The MR89 Tuner automatically switches between Stereo and Monaural FM Broadcasts. When a Stereo FM Broadcast is received, the Front Panel Information Display indicates the Stereo Mode by the letters “ST.” To change the reception mode to MONO press and release the Front Panel MONO Push-button to combine left and right stereo signals to a FM Monophonic signal. The ST indication will be extinguished. Refer to figure 46.

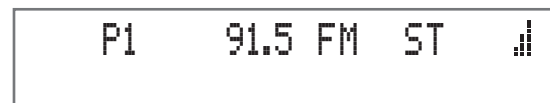

Figure 46

SIGNAL Push-Button Display of Multipath and Noise

The relative signal strength of the received Station indicated as vertical columns on the right side of the Front Panel Information Display is only one indication of the signal quality. Refer to figure 47.

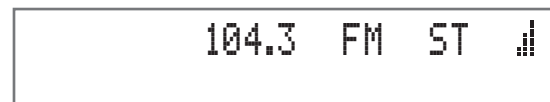

Figure 47

The MR89 Tuner provides two additional displays to better indicate the quality of the received FM Station Signal. These displays include Multipath and Noise. To activate these two displays perform the following:

1. Press and release the Front Panel SIGNAL Push-button. The LED above the SIGNAL Push-button will illuminate. The Front Panel Information Display will indicate “Mpath: _ _ _ _ Noise: _ _ _ _” on the second line of the Front Panel Information Display. Refer to figure 48.



Figure 48

Multipath interference occurs when the MR89 receives two or more signals from the Broadcast Station to which it is tuned. The first signal received is the direct signal from the station and any additional signals received occur as a result of the direct signal reflected off of some object such a building or terrain (hill/mountain). The reflected signal(s) arrives at the FM Antenna delayed in time do to the longer travel distance incurred. This

delayed signal results in an increase in distortion and a reduction in Stereo Separation. Refer to figure 49. To reduce or eliminate Multipath, reorient the FM Antenna for minimum indication of Multipath even if the Signal Strength indicates less signal.



Figure 49

Noise received along with the desired FM Broadcast Signal can occur from a variety sources, both local and distant. If orienting the FM Antenna doesn't either reduce or eliminate the noise, an antenna with more gain and directional capability might be required. Refer to figure 50.

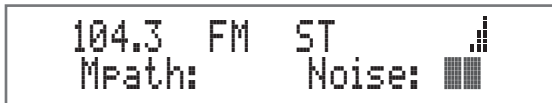

Figure 50

Figure 51 illustrates a received FM Broadcast with both Multipath and Noise.



Figure 51

2. Press the BAND Front Panel Push-button to select AM. The Front Panel Information Display will indicate "Signal: _____" on the second line of the Front Panel Information Display. Refer to figure 52.

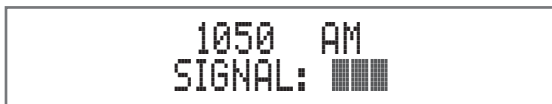

Figure 52

Tune to the weakest AM Station in your area and then orient and/or change the placement of the supplied RAA2 AM Antenna for maximum Signal indication on line 2 of the info display; and minimum audible noise and distortion.

Reception of FM and AM Broadcasts is largely determined by local conditions. For additional assistance contact your McIntosh Dealer, as they are very familiar with reception conditions in your area.

3. Press the SIGNAL Front Panel Push-button to return the Front Panel Information Display to the previous display.

DISPLAY Push-Button Text Information

The MR89 Tuner supports display of text from many FM radio Stations. When available from a FM Broadcast Station, the text information appears on the second line of the Front Panel Information Display. Information longer than 20 characters will scroll from right to left. This information may include some or all of the following:

- A. Station Call Letters and/or Frequency.
- B. Type of Program and/or music format.
- C. Name of the Artist.
- D. Name of the Song.

Refer to figures 53, 54, 55 and 56 for examples of the Text Information.

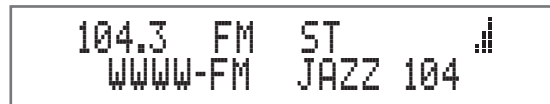

Figure 53

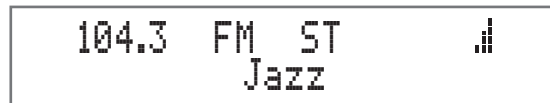

Figure 54



Figure 55

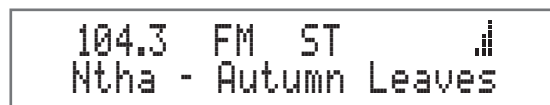

Figure 56

Note: Some stations do not broadcast Text Information. In that case, no information is displayed, regardless of the Tuner Radio Text setting. Weak broadcast signals might result in an interruption of the text information and/or incorrect characters displayed. If this occurs, try re-orienting the FM Antenna and/or replacing the antenna with an improved reception model. See your McIntosh Dealer for assistance.

The text information may be disabled in user setup, see page 18. If text information is enabled, the DISPLAY push-button can be used in round-robin fashion to either DISPLAY: Genre, Radio Text, or text can be temporarily Muted. Refer to figures 57, 58 and 59.



Figure 57



Figure 58



Figure 59

Reset of Microprocessors

In the unlikely event the controls of the MR89 stop functioning, the microprocessors can be reset by performing the following:

1. Press and hold in the STANDBY/ON Push-button for approximately five seconds until the STANDBY/ON LED is extinguished, and then release the push-button.
2. Press the STANDBY/ON Push-button and the MR89 will resume normal operation..



FM Specifications

Tuning Range 87.5MHz - 108.0MHz (Europe)
88.1MHz - 107.9MHz (USA)
76MHz - 108MHz (Japan)

Antenna Input 75 Ohms,
Type "F" Coax connector

Useable Sensitivity (26dB SNR) 1 μ V

Signal To Noise Ratio Mono: 70dB
Stereo: 68dB

Frequency Response \pm 1dB 20 to 18,000Hz

Harmonic Distortion Mono: 0.1%
Stereo: 0.3%

Channel Selectivity 70dB Adjacent Channel

Stereo Separation 45dB

AM Specifications

Tuning Range 531kHz - 1701kHz (Europe)
530kHz - 1700kHz (USA)
531kHz - 1629kHz (Japan)

Antenna Input RAA2 (supplied),
Type "RJ45" connector

Sensitivity 350 μ V/m

Signal To Noise Ratio 55dB

Frequency Response \pm 1dB 20Hz - 15kHz,
-6dB 3kHz

Harmonic Distortion 0.1%

Selectivity 45dB Adjacent Channel

General Specifications

Rated Output

1Vrms Unbalanced, 2Vrms Balanced

Output Impedance

100 ohms Unbalanced or Balanced

Digital Output

Optical: -15dbm to -21dbm (PCM)

Coaxial: 0.5Vp-p/75 ohm (PCM)

Sampling Frequency: 48kHz (PCM)

AM Antenna Input

Balanced, RJ45 connector (for use only
with supplied McIntosh RAA2 Remote AM
Antenna)

RAA2 Remote AM Antenna Overall

Dimensions

Width is 6 inches (15.24cm)

Height is 2-1/2 inches (6.35cm)

Depth is 1-1/2 inches (3.81cm)

Power Requirements

100V ~ 50/60Hz, 30 watts 220V ~ 50/60Hz, 30 watts

110V ~ 50/60Hz, 30 watts 230V ~ 50/60Hz, 30 watts

120V ~ 50/60Hz, 30 watts 240V ~ 50/60Hz, 30 watts

*Note: Refer to the rear panel of the MR89 for
the correct voltage.*

Dimensions

Overall

Width is 17-1/2 inches (44.45cm)

Height is 6 inches (15.24cm) including feet

Depth is 18 inches (45.72cm) including the Front
Panel, Knobs and Cables

Weight 23.0 pounds (11.6 kg) net,
37.5 pounds (18.1 kg) in shipping carton

Shipping Carton Dimensions

Width is 26-1/2 inches (67.3cm)

Depth is 24-1/4 inches (62.2cm)

Height is 11-3/4 inches (29.9cm)

Packing Instructions

In the event it is necessary to repack the equipment for shipment, the equipment must be packed exactly as shown below.

Use the original shipping carton and interior parts only if they are all in good serviceable condition.

If a shipping carton or any of the interior part(s) are needed, please call or write Customer Service Department of McIntosh Laboratory. Refer to page 3.

See the Part List for the correct part numbers.

Parts List

Quantity	Part Number	Description
4	017937	Plastic Foot
1	033725	Inner Carton Top Pad
1	033836	Inside Carton Only
4	033837	Pad Foam End Cap
1	033838	Shipping Carton Only
1	034301	Bottom Pad
2	034446	Foam Plug
4	400159	#10-32 X 3/4" Screw
4	404080	#10 Flat Washer

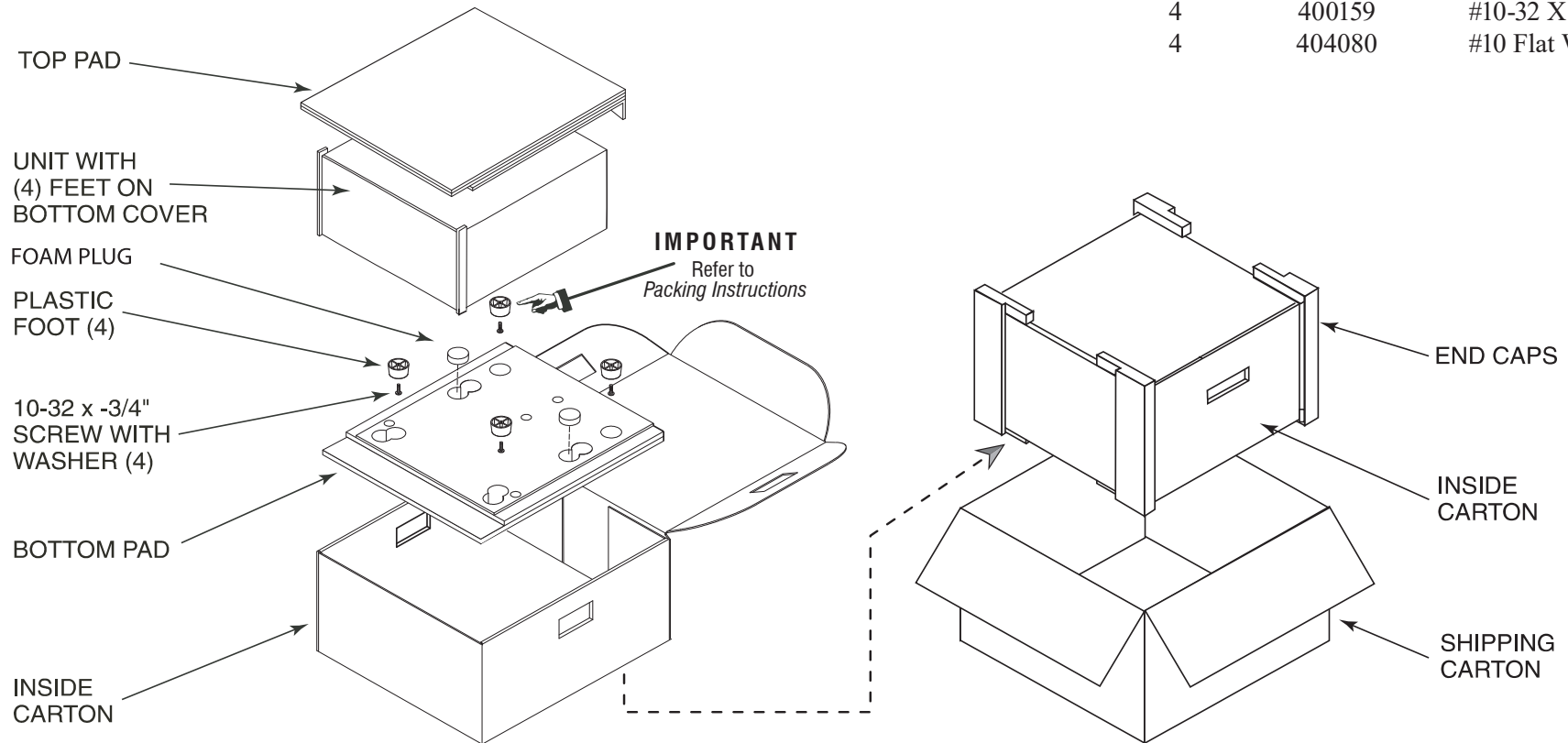

It is very important that the four plastic feet are attached to the bottom of the equipment.

This will ensure the proper equipment location on the bottom pad. Failure to do this will result in shipping damage.



McIntosh Laboratory, Inc.
2 Chambers Street
Binghamton, NY 13903
www.mcintoshlabs.com

The continuous improvement of its products is the policy of McIntosh Laboratory Incorporated who reserve the right to improve design without notice.

Printed in the U.S.A.